



Outdoor PTZ / Speed Dome Camera Hardware Manual

193, 194, 195, 196

2014/02/05



ACTi
Connecting Vision

Table of Contents

Precautions 4

Safety Instructions	6
---------------------------	---

Introduction..... 7

List of Models.....	7
Package Contents.....	8
Physical Description	9

Installation..... 11

Step 1: Unpack the Camera	11
Step 2: Mount the Camera	13
Mounting Options.....	13
Other Mounting Accessories	14
How to Mount the Outdoor PTZ	15
Step 3: Waterproof the Cable Connections	18
How to Waterproof the Cable Using the Cable Gland	19
How to Waterproof the Cable Using the Conduit Gland	23
How to Use the Junction Box.....	27
Step 4: Connect the Equipment.....	30
How to View the Camera on Your PC	30

Other Connections and Accessories 31

How to Connect Digital Input / Digital Output Devices.....	31
How to Use the Power Adapter.....	36
How to Replace the Fuse.....	36
How to Attach the Safety Wire Strap.....	38
How to Replace the Dome Cover.....	40

Accessing the Camera 42

Configure the IP Addresses 42

Access the Camera..... 46

Precautions

Read these instructions

You should read all the safety and operating instructions before using this product.

Heed all warnings

You must adhere to all the warnings on the product and in the instruction manual. Failure to follow the safety instructions given may directly endanger people, cause damage to the system or to other equipment.

Servicing

Do not attempt to service this video device yourself as opening or removing covers may expose you to dangerous voltage or other hazards. Refer all servicing to qualified service personnel.

Trademarks

All names used in this manual are probably registered trademarks of respective companies.

Liability

Every reasonable care has been taken during the writing of this manual. Please inform your local office if you find any inaccuracies or omissions. We cannot be held responsible for any typographical or technical errors and reserve the right to make changes to the product and manuals without prior notice.

Federal Communications Commission Statement



This equipment has been tested and found to comply with the limits for a class B digital device, pursuant to Part 15 of the FCC Rules. These limits are designed to provide reasonable protection against harmful interference in a residential installation. This equipment generates, uses, and can radiate radio frequency energy and, if not installed and used in accordance with the instructions, may cause harmful interference to radio communications. However, there is no guarantee that interference will not occur in a particular installation. If this equipment does cause harmful interference to radio or television reception, which can be determined by turning the equipment off and on, the user is encouraged to try to correct the interference by one or more of the following measures:

- Reorient or relocate the receiving antenna.
- Increase the separation between the equipment and receiver.
- Connect the equipment into an outlet on a circuit different from that to which the receiver is connected.
- Consult the dealer or an experienced radio/TV technician for help.

Warning: Changes or modifications to the equipment that are not expressly approved by the responsible party for compliance could void the user's authority to operate the equipment.

European Community Compliance Statement



This product has been tested and found to comply with the limits for Class B Information Technology Equipment according to European Standard EN 55022 and EN 55024. In a domestic environment, this product may cause radio interference in which cause the user may be required to take adequate measures.

Safety Instructions

Cleaning

Disconnect this video product from the power supply before cleaning.

Attachments

Do not use attachments not recommended by the video product manufacturer as they may cause hazards.

Do not use accessories not recommended by the manufacturer

Only install this device in a dry place protected from weather.

Servicing

Do not attempt to service this video product yourself. Refer all servicing to qualified service personnel.

Damage Requiring service

Disconnect this video product from the power supply immediately and refer servicing to qualified service personnel under the following conditions:

- 1) When the power-supply cord or plug is damaged.
- 2) If liquid has been spilled or objects have fallen into the video product.
- 3) If the inner parts of the video product have been directly exposed to rain or water.
- 4) If the video product does not operate normally by following the operating instructions in this manual. Adjust only those controls that are covered by the instruction manual, as an improper adjustment of other controls may result in damage, and will often require extensive work by a qualified technician to restore the video product to its normal operation.

Safety Check

Upon completion of any service or repairs to this video product, ask the service technician to perform safety checks to determine if the video product is in proper operating condition.

Introduction













List of Models

This hardware manual contains the following model:

I93		1MP Outdoor PTZ with D/N, Extreme WDR, SLLS, 30x Zoom lens
I94		2MP Outdoor PTZ with D/N, Extreme WDR, SLLS, 30x Zoom lens
I95		1MP Outdoor Speed Dome with D/N, Extreme WDR, SLLS, 30x Zoom lens
I96		2MP Outdoor Speed Dome with D/N, Extreme WDR, SLLS, 30x Zoom lens

Package Contents

Check if the following items come with the camera package. If any of them is missing, please contact your local sales agents or the [Customer Help Desk \(CHD\)](#).

Camera	Power Cord	Power Adapter
		
Cable Gland	Conduit Gland	Gland Rubber Rings (x2)
		
Hex Screwdriver	Screws	Universal Plugs
		
Safety Strap	Quick Installation Guide	Warranty Card
		

Physical Description



1) Reset Button

The reset button is used to restore the factory default settings of the camera, including the administrator's password.

To reset the camera, do the following:

- a. Loosen the four (4) screws using the bundled hex screwdriver to remove the cover.
- b. Press and hold the reset button for at least 5 seconds or until the Power LED goes off.

2) Power LED

The Power LED lights red when the camera is powered up.

3) Ethernet Port

The Ethernet port connects to a network using a standard Ethernet cable.

4) AC 24V Power Input

This jack connects to the power adapter and power cord to supply power to the camera.

5) Digital Input / Output

The colored cables connect to digital input or output devices, such as an alarm trigger, panic button, etc. Digital Input (DI) and Digital Output (DO) devices are used for applications like motion detection, event triggering, alarm notifications, etc. Please refer to [How to Connect Digital Input / Digital Output Devices on page 31](#) for information on how to connect DI/DO devices to your camera.

6) Audio Output

This jack connects to an audio output device, such as a speaker.

7) Audio Input

This jack connects to an audio input device, such as a microphone with built-in amplifier.

NOTE: Make sure that the connected audio input device has a built-in amplifier. Connecting an ordinary microphone will dwarf sounds and will result in inaudible recording.

Installation

Step 1: Unpack the Camera

NOTE: To avoid scratches or leaving fingerprints on the dome cover, it is recommended to retain the plastic covering the dome cover until the camera is completely installed. However, the plastic has been removed on the pictures in this documentation to show clarity of the procedures being described.

1. Loosen the four (4) screws using the hex screwdriver included in the camera package.

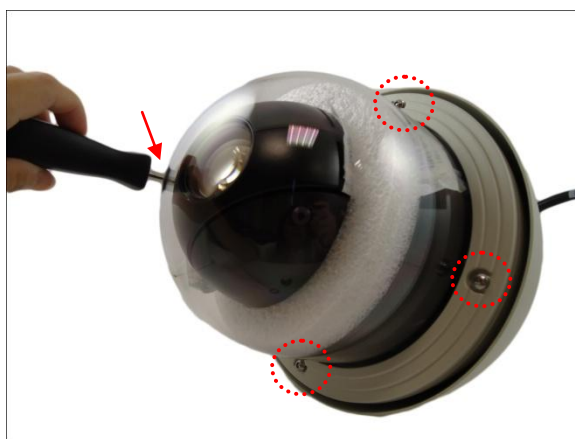

2. Carefully lift the camera cover and place it aside.



NOTE: The cover is attached to the camera by a metallic wire strap; do not abruptly lift the cover.

3. Remove the styrofoam and silicon bags from the camera.



4. Align the screw holes and tightly secure the screws using the bundled hex screwdriver.









Step 2: Mount the Camera



Mounting Options

There are several mounting options that you can use to install the camera.



For more information about mounting solutions and accessories, please visit our website

(<http://www.acti.com/mountingselector>).

Mount Types	Accessories	
Pendant Mount	Suitable when mounting the Outdoor PTZ on a hard ceiling.	
	PMAX-0102 (Straight Tube w/o Bracket)	
	PMAX-0103 (Straight Tube with Bracket)	
Straight Wall Mount	Suitable when mounting the Outdoor PTZ on a straight wall.	
	PMAX-0305 (Heavy Duty Wall Mount)	
Vertical Pole Mount	Suitable when mounting the Outdoor PTZ on a vertical pole.	
	PMAX-0305 	PMAX-0503 
Horizontal Pole Mount	Suitable when mounting the Outdoor PTZ on a horizontal pole.	
	PMAX-0102 	PMAX-0503 

Mount Types	Accessories
Corner Mount	Suitable when mounting the Outdoor PTZ on a corner wall.
	<div style="display: flex; align-items: center; justify-content: space-around;"> <div style="text-align: center;"> <p>PMAX-0305</p>  </div> <div style="font-size: 2em;">+</div> <div style="text-align: center;"> <p>PMAX-0402</p>  </div> </div>

Other Mounting Accessories

Accessories	
<p>PMAX-0700 (Junction Box)</p> 	<p>PMAX-0104 (Extension Tubes)</p> 

How to Mount the Outdoor PTZ

Depending on the desired mounting solution, you may need to install the mounting solution first before connecting the cables or the cables may be connected first before installing the mounting solutions. Below are basic installation procedures, however for more detailed information, download the Installation Guide from the website (<http://www.acti.com/mountingselector>).

1. Install the Mounting Solution

Check the Installation Guide for detailed information.

2. Insert the Cable

Insert the camera cables through the mounting tube (e.g. heavy wall mount, straight tube, extension tube, etc.) and through a hole in the wall or ceiling.

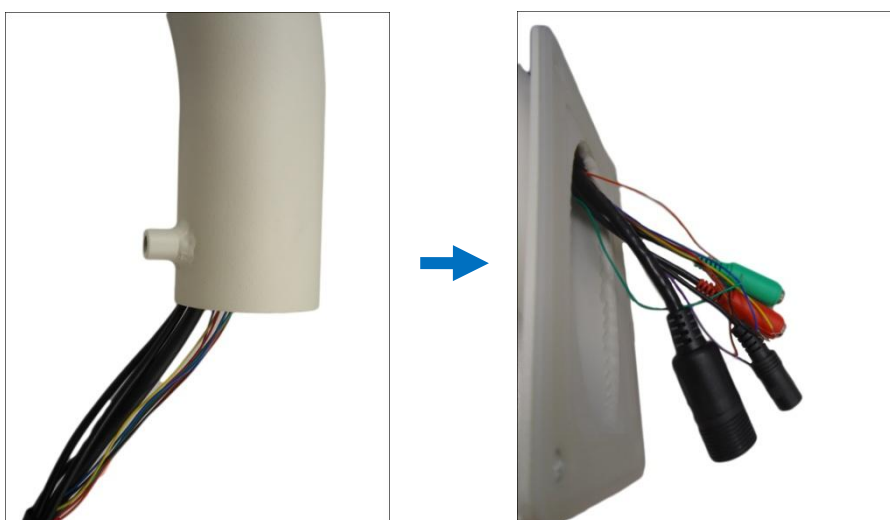

CAUTION: The camera itself is waterproof, however take note that the cable connections are not. If the cable connections will be exposed outdoors, make sure to shield or adapt proper waterproofing methods. See [Step 3: Waterproof the Cable Connections](#) on page 18.

DISCLAIMER: ACTi will not be responsible for camera damage caused by water entering the cable connections.

3. Mount the camera

1. Align the gap on the camera to the tab inside the mounting solution and insert the camera through the mounting tube.

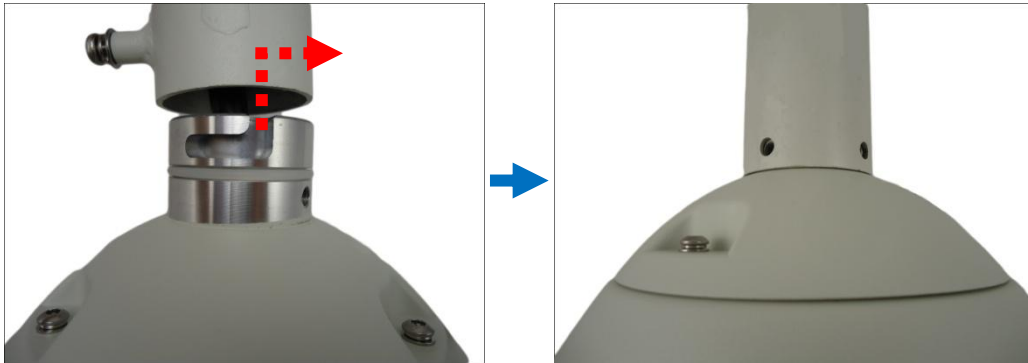

2. Attach the screws included in the camera package to secure the camera.



3. For added security, attach the safety wire strap to the camera and the mounting solution. See [How to Attach the Safety Wire Strap](#) on page 38 for detailed instructions.



Below is an example of mounting the camera using pendant mount with the cables inside the ceiling.



Step 3: Waterproof the Cable Connections

The camera itself is waterproof, however take note that the cable connections are not.

If the camera is mounted directly on the ceiling/wall where the cables pass through the ceiling/wall, then your installation is complete and you do not need to waterproof the cable connections.





However, if the camera is mounted where the cables may be exposed then it is recommended to waterproof the cable connections or use a junction box.

The camera comes with a **Cable Gland** and **Conduit Gland**. It is recommended to use one of these glands when a high PoE injector will be used with the camera. However, if the bundled power adapter will be used or digital input/output devices will be connected (see [How to Connect Digital Input / Digital Output Devices](#) on page 31), it is recommended to house the cables inside the junction box (see [How to Use the Junction Box](#) on page 27).

Cable Gland	Conduit Gland
	
<p>For use with an exterior-grade Ethernet cable (not included in the package).</p>	<p>For use with 1/2" flexible conduit (not included in the package).</p>
	
<p>See How to Waterproof the Cable Using the Cable Gland on page 19.</p>	<p>See How to Waterproof the Cable Using the Conduit Gland on page 23.</p>

How to Waterproof the Cable Using the Cable Gland

1. Prepare the following items:

Cable Gland	Gland Rubber Ring	Exterior-Grade Ethernet Cable	Waterproof Tape
		 NOTE: Not included in the camera package.	 NOTE: Not included in the camera package.

2. Detach the cable gland as shown below.



3. Insert the clamping nut through the Ethernet cable.



4. Insert the Ethernet cable through the sealing rubber and claw.



5. Attach one (1) supplied rubber ring on the gland body (smooth end).

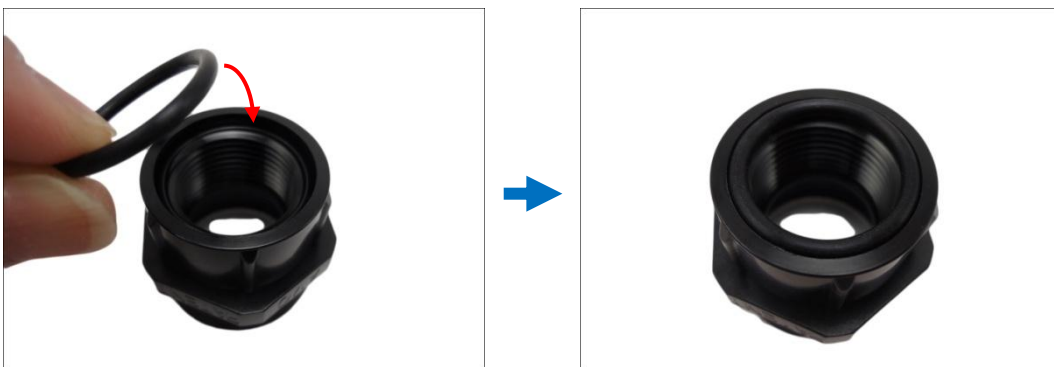

NOTE: Make sure the rubber ring is completely aligned on the gap on the gland body.

6. Attach the gland body to the Ethernet port of the camera.



IMPORTANT!

Make sure the rubber ring is completely aligned and flat on the gland body to avoid possible water leakage.

7. Connect the Ethernet connector to the Ethernet port of the camera.



8. Insert the sealing rubber and claw into the cable gland body.

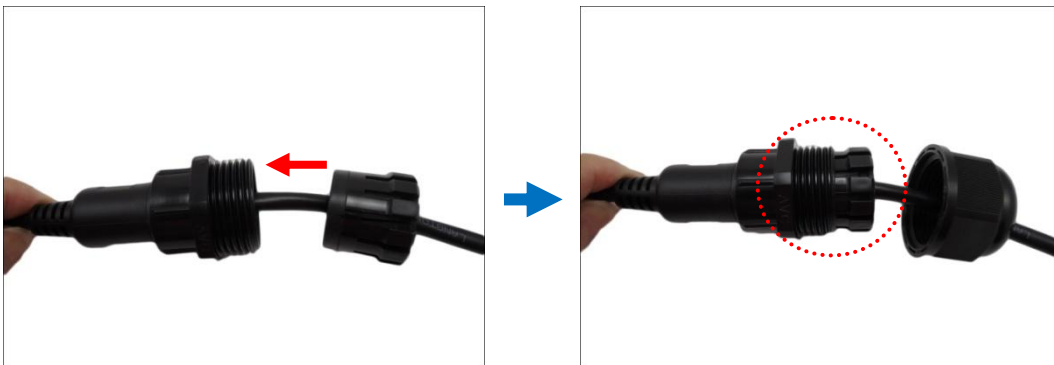

9. Attach the clamping nut to the cable gland body. Make sure the clamping nut is tightly secured and the rubber is squeezed in to avoid water leakage.

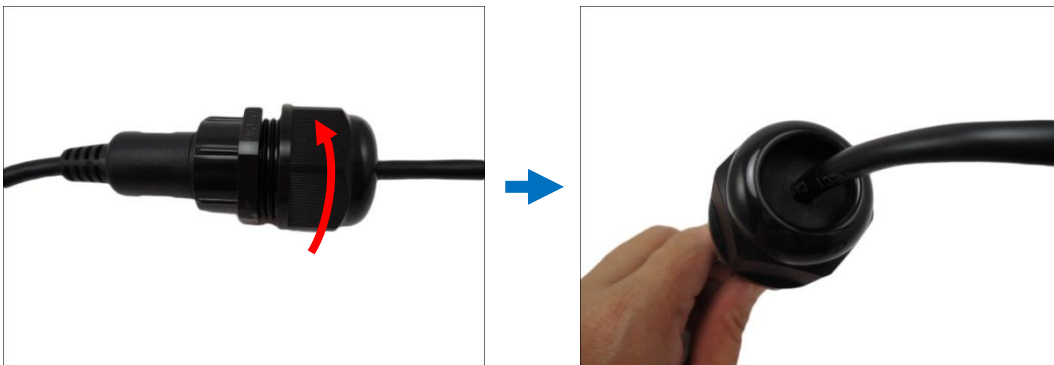

10. Arrange all unused cables and wrap them with the waterproof tape.

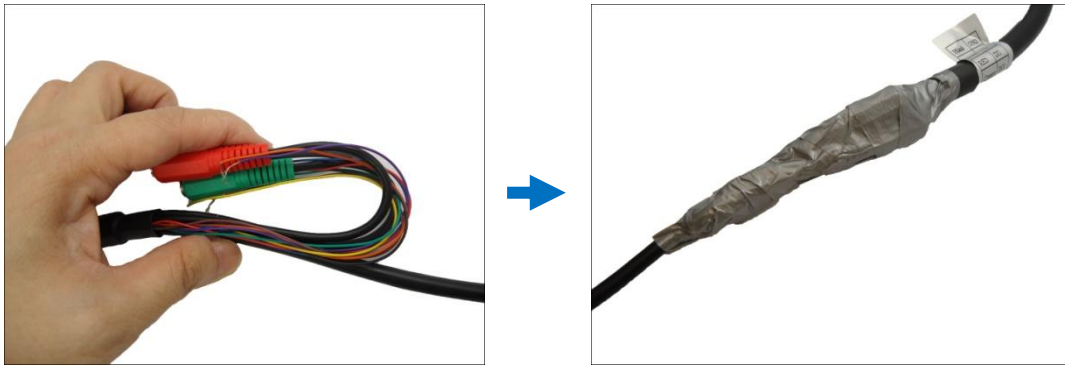





NOTE:

- Different applications and installation environments require different types of waterproofing methods which may not be covered in this manual. Check your installation environment and adapt a suitable waterproofing method.
- If the camera is installed outdoors and the bundled power adapter is used, be sure to protect it from different environmental factors. It is recommended to place the power adapter indoors or housed it inside a junction box (see [How to Use the Junction Box](#) on page 27).

DISCLAIMER: ACTi will not be responsible for camera damage caused by improper use of the power adapter.

How to Waterproof the Cable Using the Conduit Gland

1. Prepare the following items:

Conduit Gland	Gland Rubber Ring	1/2" Flexible Conduit	Waterproof Tape
		 <p>NOTE: Not included in the camera package.</p>	 <p>NOTE: Not included in the camera package.</p>

2. Detach the conduit gland as shown below.



3. Insert the Ethernet cable through the flexible conduit. Then insert the clamping nut through the flexible conduit.



4. Insert the sealing rubber and attach it at the end of the flexible conduit.



5. Attach one (1) supplied rubber ring on the gland body (smooth end).

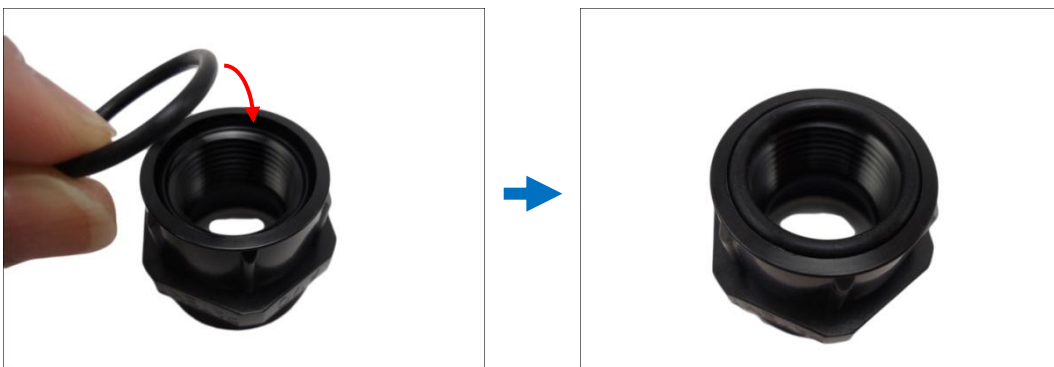

NOTE: Make sure the rubber ring is completely aligned on the gap on the gland body.

6. Attach the gland body to the Ethernet port of the camera.

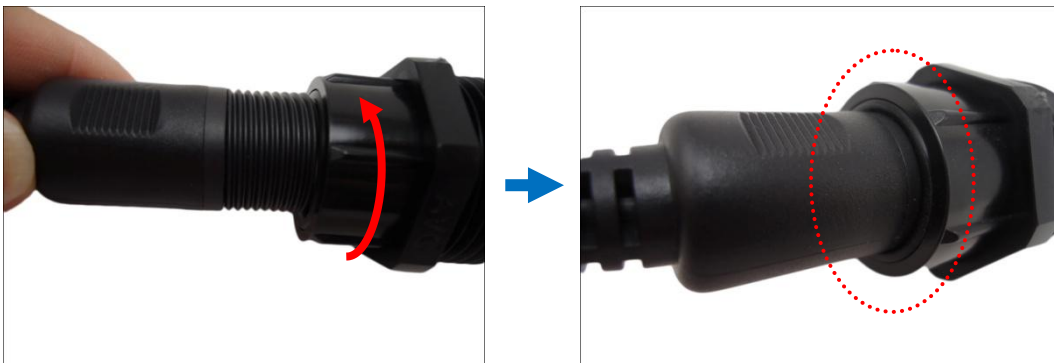

IMPORTANT!

Make sure the rubber ring is completely aligned and flat on the gland body to avoid possible water leakage.

7. Connect the Ethernet connector to the Ethernet port of the camera.



8. Insert the sealing rubber into the conduit gland body.

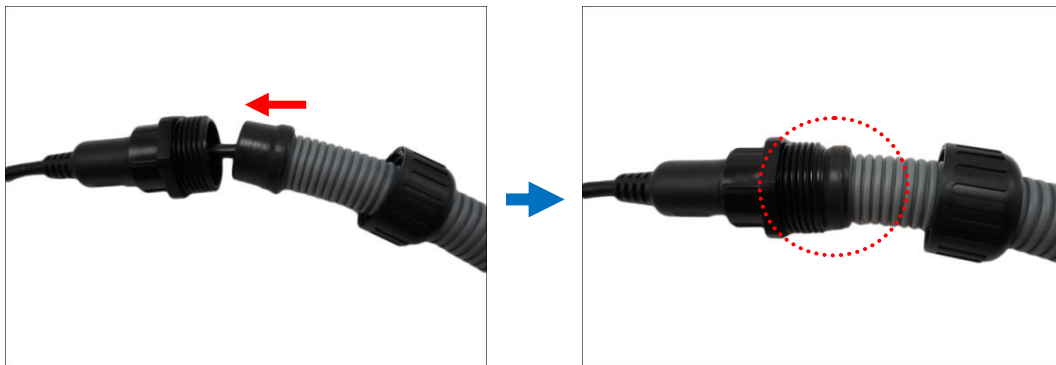

9. Attach the clamping nut to the conduit gland body. Make sure the clamping nut is tightly secured to avoid water leakage.



10. Arrange all unused cables and wrap them with the waterproof tape.

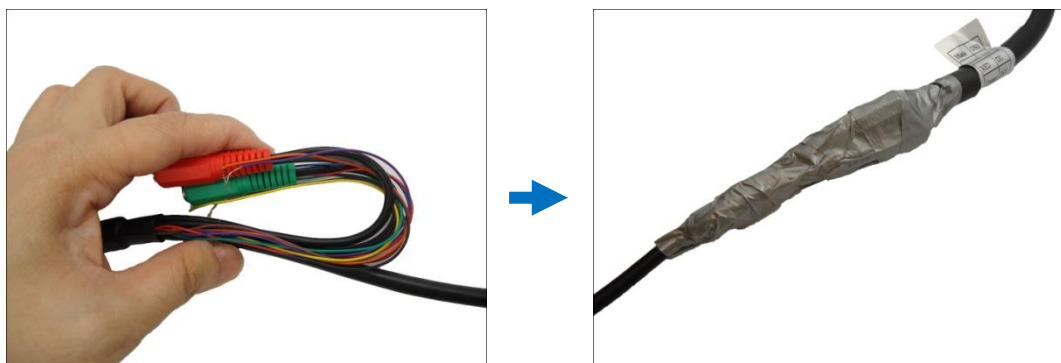

NOTE:

- Different applications and installation environments require different types of waterproofing methods which may not be covered in this manual. Check your installation environment and adapt a suitable waterproofing method.
- If the camera is installed outdoors and the bundled power adapter is used, be sure to protect it from different environmental factors. It is recommended to place the power adapter indoors or housed it inside a junction box (see [How to Use the Junction Box](#) on page 27).

DISCLAIMER: ACTi will not be responsible for camera damage caused by improper use of the power adapter.

How to Use the Junction Box

When the camera is mounted with the cable connections exposed, use the **PMAX-0700 Junction Box** (not included in the package) to house the cable connections.



1. Place all the cables and the power adapter (if using one) inside the junction box. Then, secure the camera mount to the junction box.



2. From the network/power source side, insert the cables, such as the Ethernet cable, through a flex conduit with 3/4" gland (flex conduit and gland not included in the package) and through one of the holes of the junction box. Then connect the necessary cables.



3. Secure the flex conduit fitting onto the junction box hole.



NOTE: The PMAX-0700 Junction Box is not a bundled accessory. Contact your sales agents to purchase.

4. When using the bundled power adapter, do the following:
 - a. Slide the voltage switch to set the adapter voltage according to the voltage standard in your location.
 - b. Connect the power cord to the power adapter.



- c. Connect the power connector of the camera to the cable connector of the adapter.



- d. Install a female power socket (not included) inside the junction box to plug the cord and power up the camera.

Below is an example of the installing the camera using the Heavy Duty Wall Mount and Junction Box.



Step 4: Connect the Equipment

How to View the Camera on Your PC

Perform the following connections to view the camera from your PC:

1. Connect the camera and the PC to the same network using Ethernet cables.
2. Connect the camera to a power supply using the supplied power adapter and power cord.

The Power LED of the camera will flash a few times and turn off as the camera mechanical components initialize. Wait for the initialization to complete. Once complete, the Power LED will light red to indicate the camera works normally.

Note: Use only the supplied power adapter and power cord that came with the camera or the optional High PoE Injector available for purchase. Using other accessories not approved by the manufacturer may cause damage to the equipment.

Other Connections and Accessories

How to Connect Digital Input / Digital Output Devices

Depending on your surveillance needs, you may need to connect digital input or output devices to your camera to trigger events or notifications.

Digital Input (DI) devices can be used to notify the camera about an activity in the camera site. DI can be triggers of events. For example, you can connect a “panic button” to the camera; as such when the panic button is pressed, the alarm signal will be sent through the camera. Other common DI device applications are emergency button, smoke detector, passive infrared sensor, etc.

Digital Output (DO) devices are external devices that are activated by the camera upon an event inside the camera. For example, you can connect an “alarm horn” to the camera; as such when an event occurs inside the camera (e.g. detected intruder), the alarm horn will sound. Other common DO device applications are motion-triggered lights, electric fence, magnetic door locks, etc.

Understanding the DI/DO Cables

You can connect up to four (4) DI and two (2) DO devices to your camera.

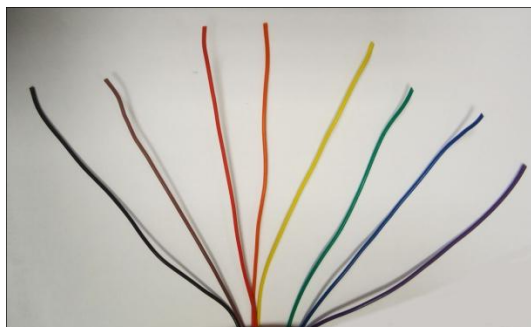

Digital Input Cables	Cable Color	Wiring Connection
Ground Pin (GND)	Black	To connect digital input devices, map the DI device wires to the following: <ul style="list-style-type: none"> • DI1 and GND • DI2 and GND • DI3 and GND • DI4 and GND
Digital Input 1 (DI1)	Orange	
Digital Input 2 (DI2)	Green	
Digital Input 3 (DI3)	Purple	
Digital Input 4 (DI4)	Brown	
<p>NOTE: In case of connecting more than one DI device, the GND pin can be commonly shared by all four (4) DI devices.</p>		

Digital Output Cables	Cable Color	Wiring Connection
12V (12V)	Red	To connect digital output devices, map the DO device wires to the following: <ul style="list-style-type: none"> • DO1 and 12V • DO2 and 12V
Digital Output 1 (DO1)	Yellow	
Digital Output 2 (DO2)	Blue	
<p>NOTE: In case of connecting two (2) DO devices, the 12V pin can be commonly shared by the two (2) DO devices.</p>		

The table below shows the DI/DO connection specifications:

Device			
DI	Connection design		TTL - compatible logic levels
	Voltage	To trigger (low)	Logic level 0: 0V ~ 0.4V
		Normal (high)	Logic level 1: 3.1V ~ 30V
Current		10mA ~ 100mA	
DO	Connection design		Transistor (Open Collector)
	Voltage & Current		< 24V DC, < 50mA

Typical Connection

Based on these specifications, if the DI device has a voltage of 0V ~ 30V or the DO device has a voltage of < 24V (< 50mA), then the camera can supply internal power to these devices and there is no need to connect the DI/DO device to an external power source.

In this case, use the Black (GND) and the Orange (DI1) cables to connect a DI device and use the Red (12V) and the Yellow (DO1) cables to connect a DO device. See wiring scheme below:

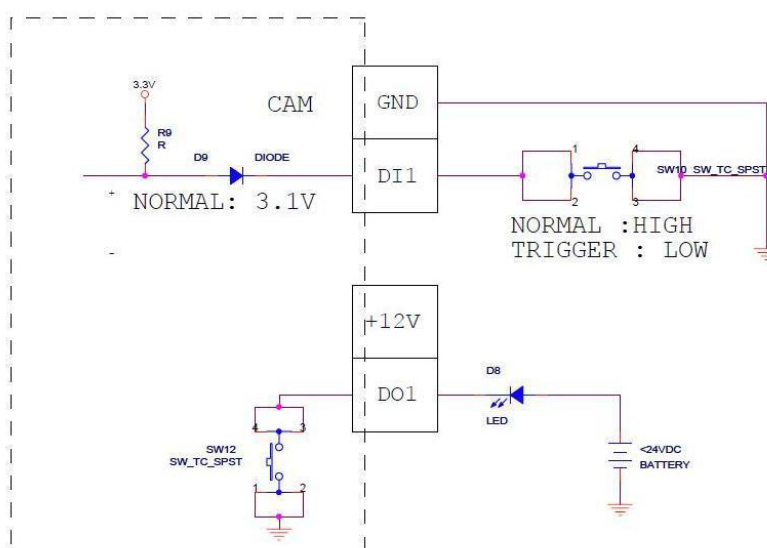

Consequently, to connect a second DI or DO device, use the Black (GND) and Green (DI2) cables to connect the second DI device, and the Red (12V) and Blue (DO2) cables for the second DO device.

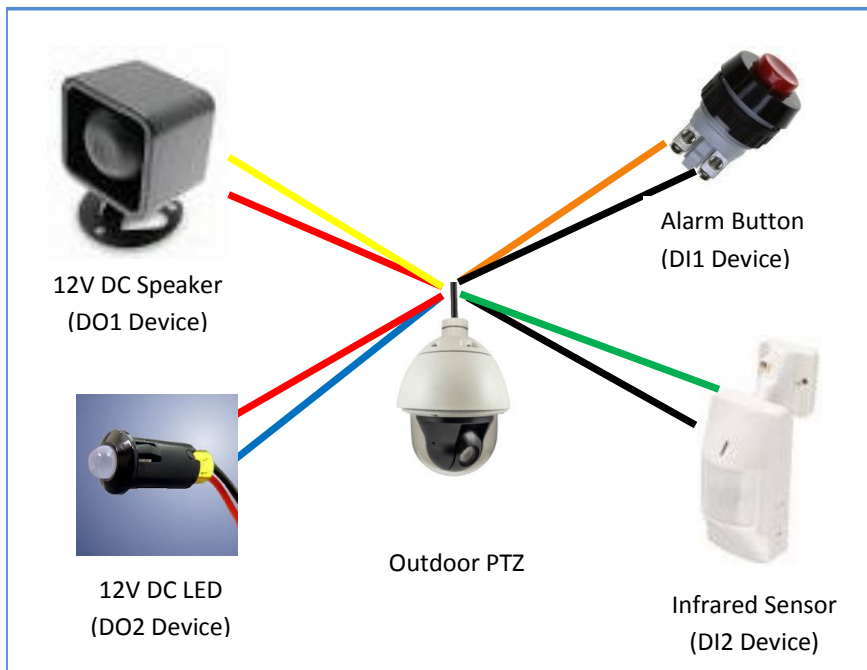

High Voltage DO Device Connection

Even though the camera provides 12V power, this may not be enough for some high voltage DO devices, such as a ceiling light or a motor that opens or closes a gate. In this case, there is a need to connect an external relay. See wiring scheme below:

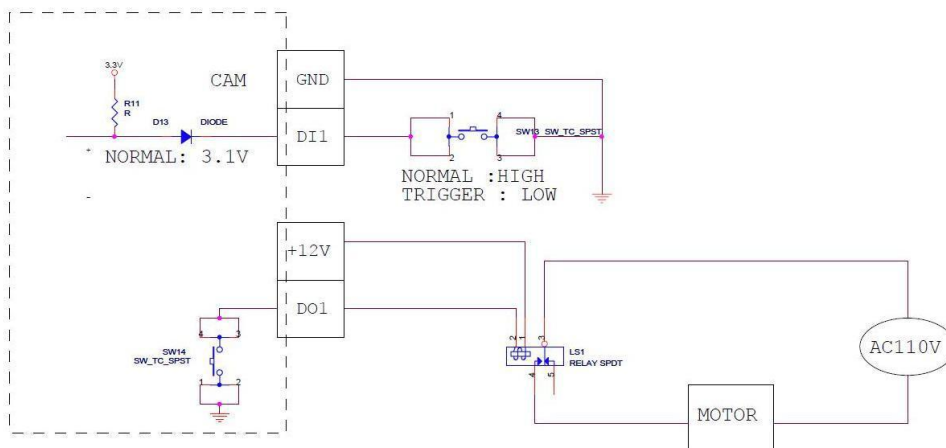

Note that when choosing an appropriate relay, please refer to its specifications and make sure they match the above design. The triggering circuit voltage has to be around 12V DC and the switch-controlled circuit voltage has to match the external power supply (e.g. 110V AC or 220V AC).

The illustration below is a graphic example of connecting a relay to a high voltage DO device.

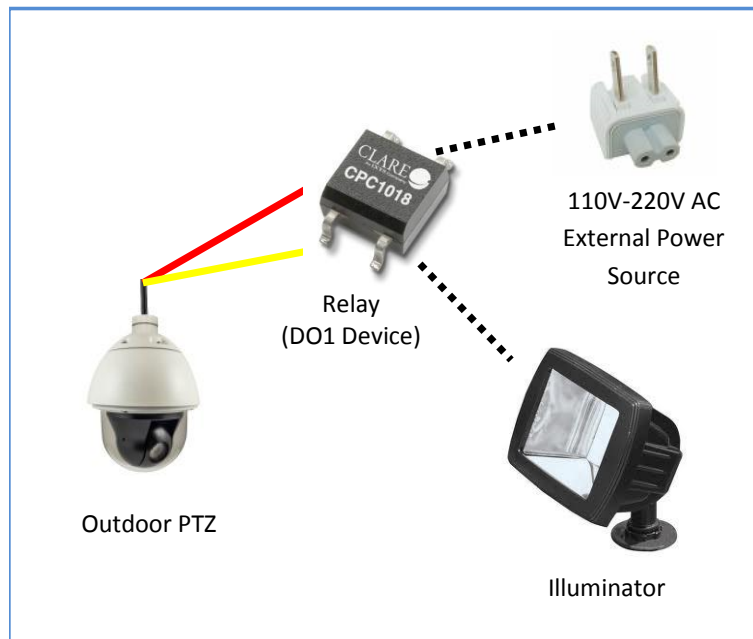

Note: For more information on DI/DO connections, please refer to the article [All about Digital Input and Digital Output](http://www.acti.com/kb/detail.asp?KB_ID=KB20091230001) (http://www.acti.com/kb/detail.asp?KB_ID=KB20091230001) in the Knowledge Base section of our website (www.acti.com).

How to Use the Power Adapter

1. Slide the voltage switch to set the adapter voltage according to the voltage standard in your location.
2. Connect the power cord to the power adapter.



3. Connect the power connector of the camera to the cable connector of the adapter.

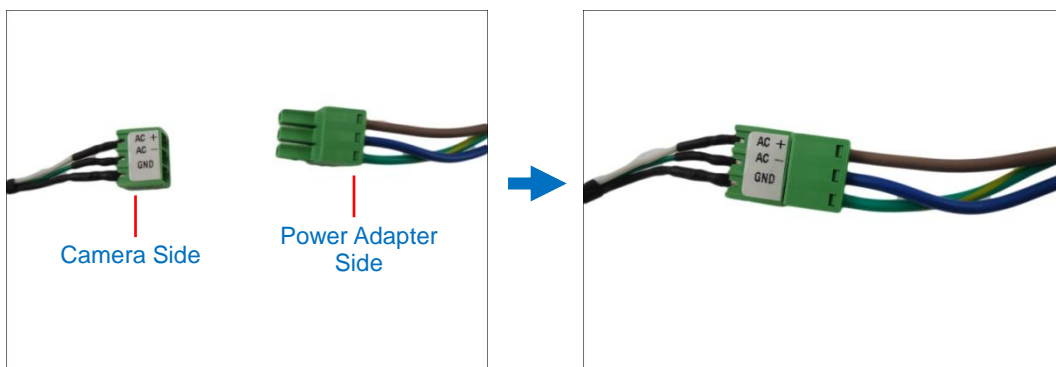

How to Replace the Fuse

With proper use, there is no need to replace the fuse that came with the power adapter. However in case of accidentally switching the wrong power voltage, a replacement fuse is already included. Follow the procedures below to replace the fuse:

1. Use a flat-head object, such as a screwdriver, to pull and remove the fuse holder from the power adapter.

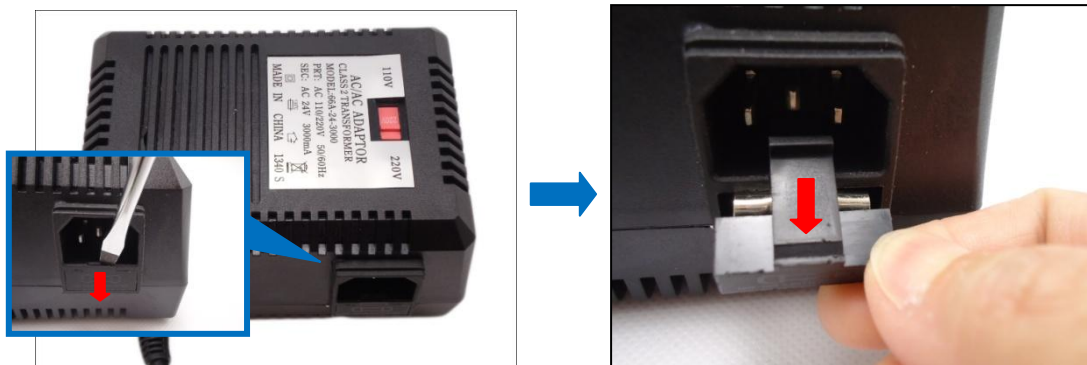

2. Remove the main fuse from its bay and pull to retrieve the replacement fuse.

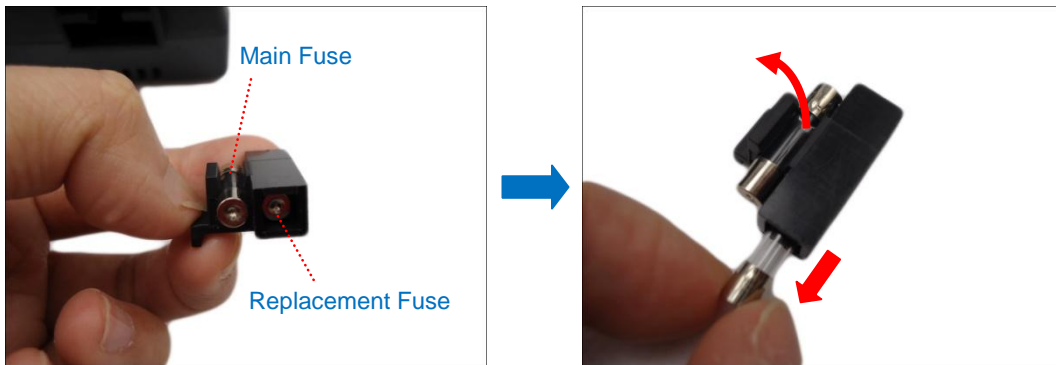

3. Push the replacement fuse onto its bay.

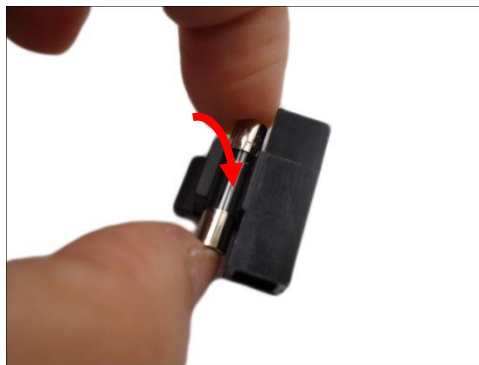

4. Insert the fuse holder back into the power adapter and push until it locks into place.

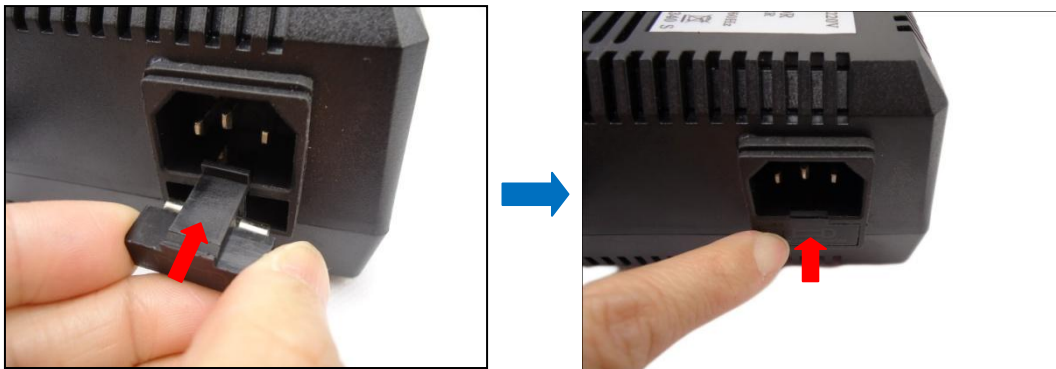

How to Attach the Safety Wire Strap

Most of ACTi's mounting accessories have a safety screw where the bundled safety wire strap can be used as additional protection to avoid dropping the camera while mounted on the high ceilings, etc.

To attach the safety wire strap, do the following:

1. Using a screwdriver, remove the screw on top of the camera.

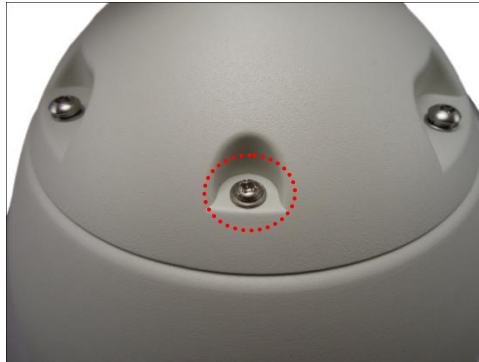

2. Insert the screw through the smaller end of the safety wire strap and attach it to the camera.

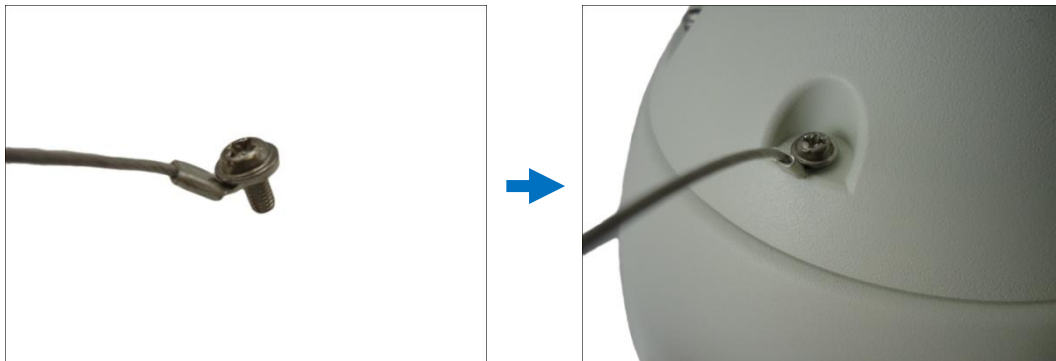

3. Remove the safety screw from the mounting solution (below is an example of the straight tube).

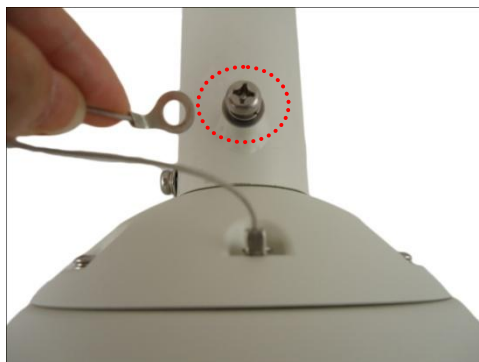

4. Align the bigger end of the safety wire strap on the mounting solution and then tightly attach the screw to lock the safety wire strap in place.

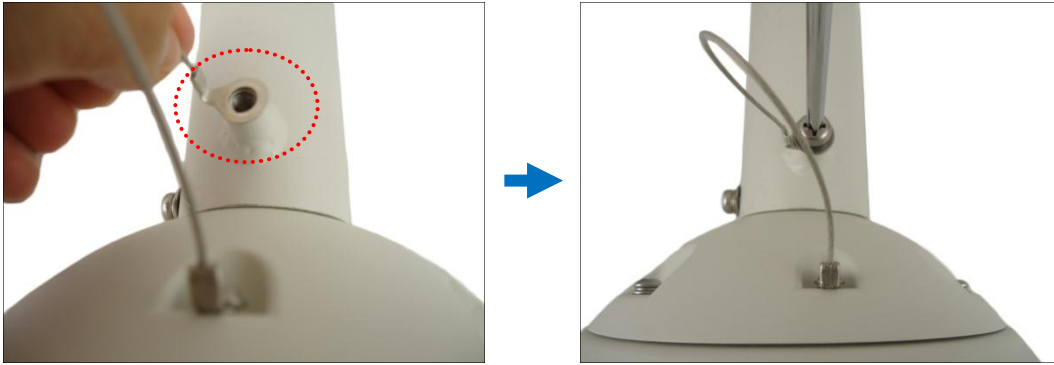

How to Replace the Dome Cover

The original dome cover that comes with the camera is Vandal Resistant (IK09). The dome cover can be replaced with a transparent or smoke Vandal Proof (IK10) dome cover available for purchase.

To replace the dome cover, do the following:

1. Loosen the four (4) screws using the hex screwdriver included in the camera package.



2. Carefully lift the cover. Using a screwdriver, remove the screw to detach the cover from the camera.



3. Prepare the replacement dome cover. Below is an example of the smoke vandal proof cover.



4. Attach the dome cover to the camera by securing the screw through the wire strap.



5. Tighten the four (4) screws to close the dome cover.



Accessing the Camera

Configure the IP Addresses

In order to be able to communicate with the camera from your PC, both the camera and the PC have to be within the same network segment. In most cases, it means that they both should have very similar IP addresses, where only the last number of the IP address is different from each other. There are 2 different approaches to IP Address management in Local Area Networks – by DHCP Server or Manually.

Using DHCP server to assign IP addresses

If you have connected the computer and the camera into the network that has a DHCP server running, then you do not need to configure the IP addresses at all – both the camera and the PC would request a unique IP address from the DHCP server automatically. In such case, the camera will immediately be ready for the access from the PC. The user, however, might not know the IP address of the camera yet. It is necessary to know the IP address of the camera in order to access it using a Web browser.

The quickest way to discover the cameras in the network is to use the simplest network search, built in the Windows system – just by pressing the “Network” icon, all the cameras of the local area network will be discovered by Windows, thanks to the UPnP function support of our cameras.

In the example below, the camera model that has just been connected to the network is successfully found.

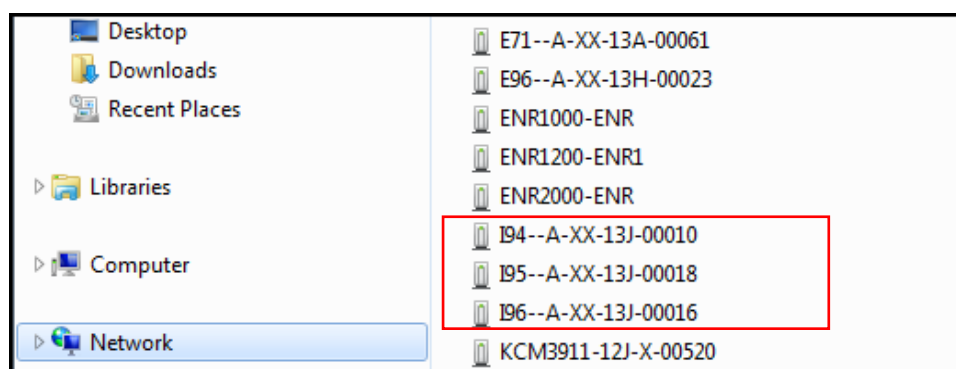

Double-click the mouse on the camera model name, the default browser of the PC is automatically launched and the IP address of the target camera is already filled in the address bar of the browser.

If you work with our cameras regularly, then **there is even a better way to discover the cameras in the network** – by using **IP Utility**. The IP Utility is a light software tool that can not only discover the cameras, but also list lots of valuable information, such as IP and MAC addresses, serial numbers, firmware versions, etc, and allows quick configuration of multiple devices at the same time.

The IP Utility can be downloaded for free from http://www.acti.com/IP_Utility

When you launch IP Utility, the list of connected cameras in the network will be shown. See sample illustration below:

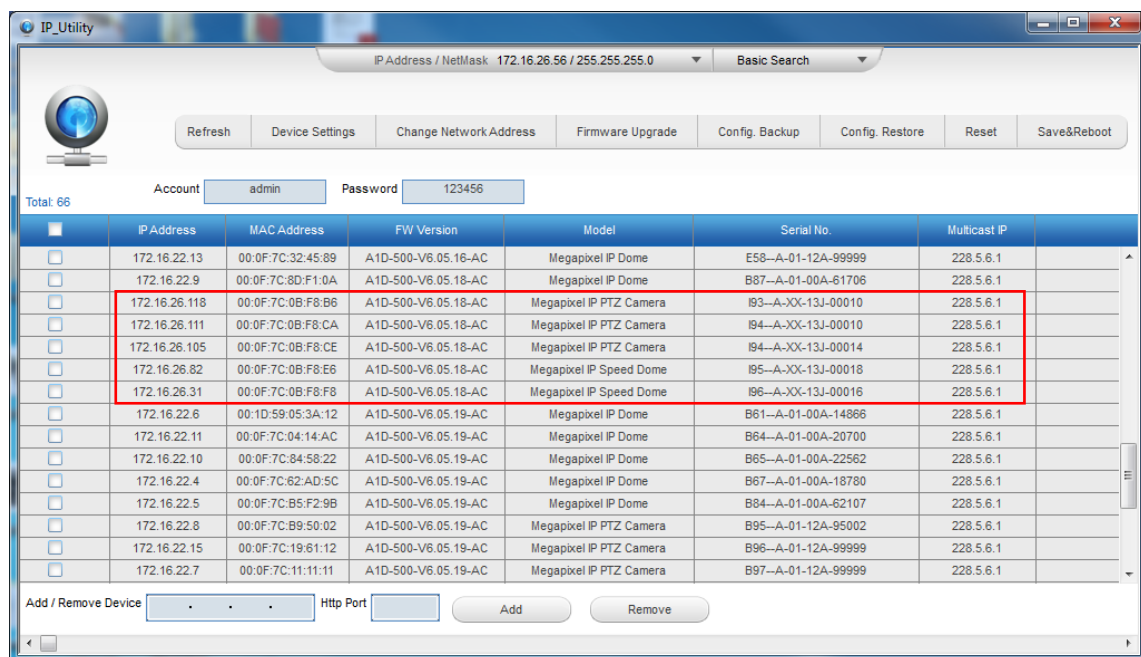

The camera model name is shown on the list. Click on the IP address to automatically launch the default browser of the PC with the IP address of the target camera already filled in the address bar of the browser.

Use the default IP address of the camera

If there is no DHCP server in the given network, the user may have to manually assign the IP addresses to both the PC and the camera to make sure they are in the same network segment.

When the camera is plugged into the network and it does not detect any DHCP services, it will automatically assign itself a default IP:

192.168.0.100

Whereas the default port number would be **80**. In order to access that camera, the IP address of the PC has to be configured to match the network segment of the camera.

Manually adjust the IP address of the PC

In the following example, based on Windows 7, we will configure the IP address to **192.168.0.99** and set Subnet Mask to **255.255.255.0** by using the steps below:

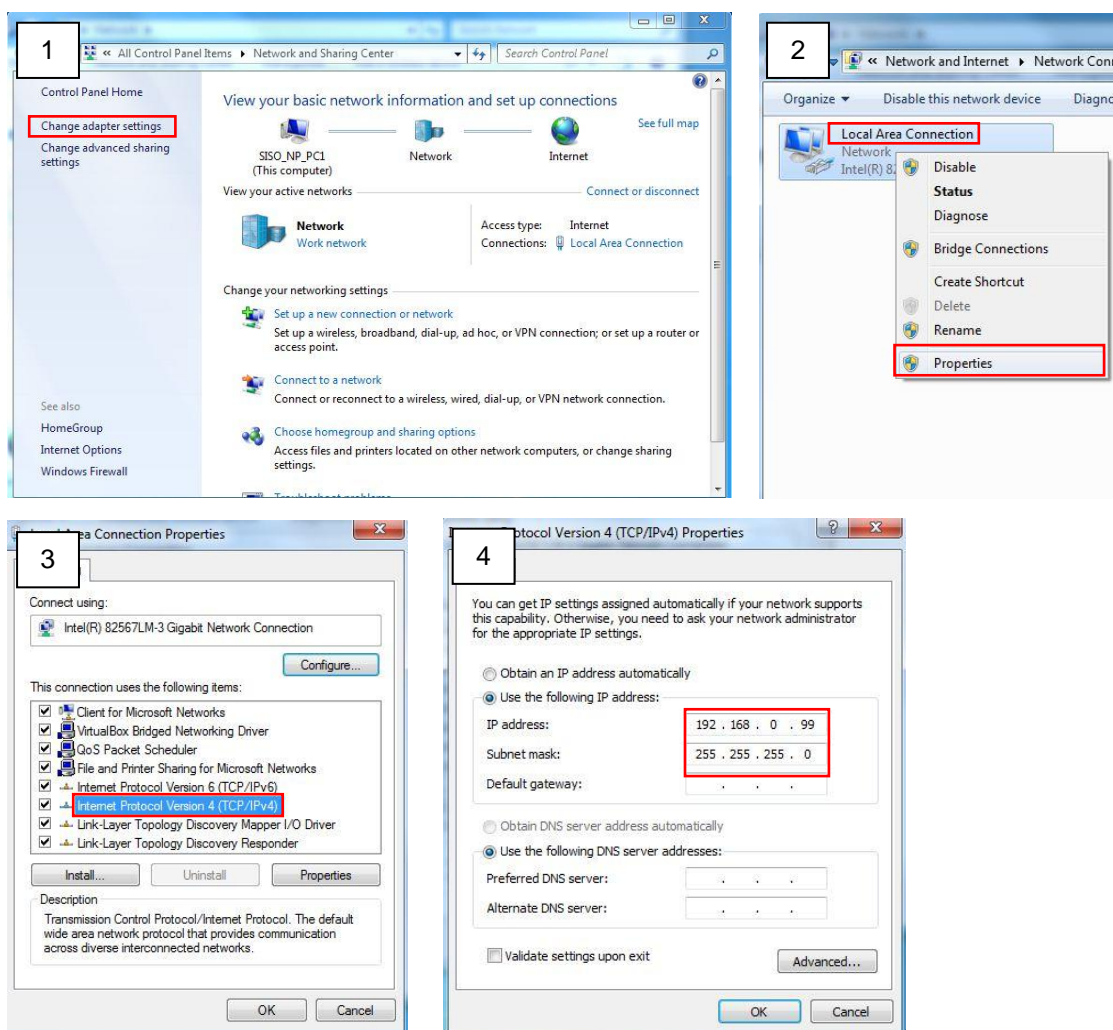

Manually adjust the IP addresses of multiple cameras

If there are more than one camera to be used in the same local area network and there is no DHCP server to assign unique IP addresses to each of them, all of the cameras would then have the initial IP address of **192.168.0.100**, which is not a proper situation for network devices – all the IP addresses have to be different from each other. The easiest way to assign cameras the IP addresses is by using **IP Utility**:

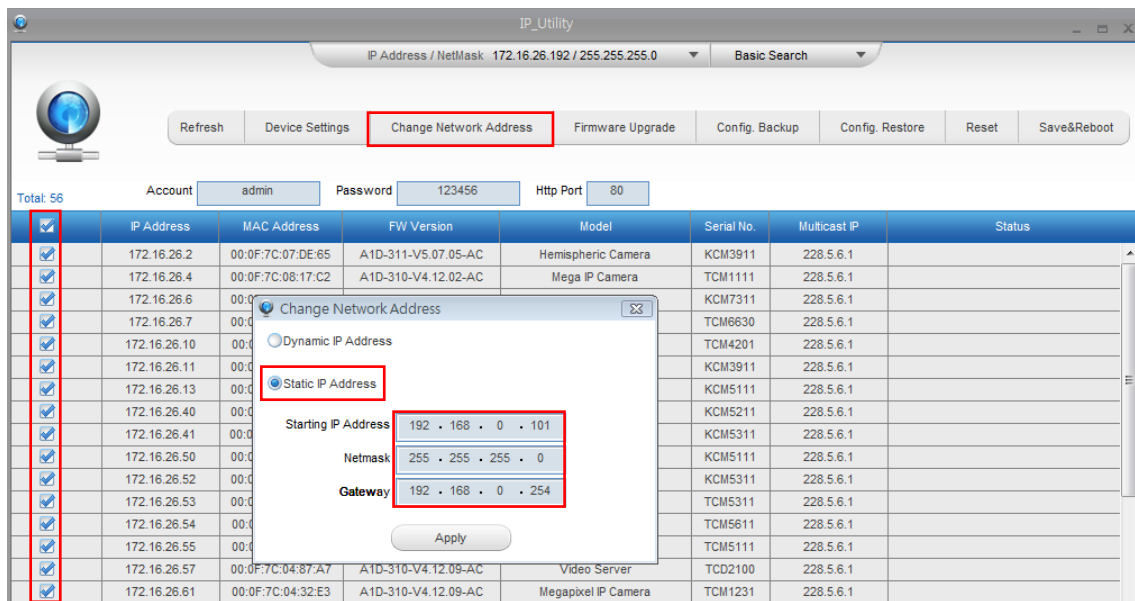

With the procedure shown above, all the cameras will have unique IP addresses, starting from 192.168.0.101. In case there are 20 cameras selected, the last one of the cameras would have the IP 192.168.0.120.

Later, by pressing the “Refresh” button of the IP Utility, you will be able to see the list of cameras with their new IP addresses.



Please note that it is also possible to change the IP addresses manually by using the Web browser. In such case, please plug in only one camera at a time, and change its IP address by using the Web browser before plugging in the next one. This way, the Web browser will not be confused about two devices having the same IP address at the same time.

Access the Camera

Now that the camera and the PC both have their unique IP addresses and are under the same network segment, you can use **Microsoft Internet Explorer** on the PC to access the camera.

You can use **any of the browsers** to access the camera, however, the full functionality is provided only for **Microsoft Internet Explorer**.

The browser functionality comparison:

Functionality	Internet Explorer	Other browsers
Live Video	Yes	Yes*
Live Video Area Resizable	Yes	No
PTZ Control	Yes	Yes
Capture the snapshot	Yes	Yes
Video overlay based configuration (Motion Detection regions, Privacy Mask regions)	Yes	No
All the other configurations	Yes	Yes

* **QuickTime** (<http://www.apple.com/quicktime/download/>) has to be installed in PC first before using any non-Internet Explorer browsers to be able to get live video feed from the camera with those browsers. It is a free and open source cross-platform multimedia player.

***Disclaimer Notice:** The camera manufacturer does not guarantee the compatibility of its cameras with QuickTime – since it is a third party software, the third party has the right to modify their utility any time which might affect the compatibility. In such cases, please use Internet Explorer browser instead.*

When using Internet Explorer browser, the ActiveX control for video stream management will be downloaded from the camera directly – the user just has to accept the use of such control when prompted so. No other third party utilities are required to be installed in such case.

The following examples in this manual are based on Internet Explorer browser in order to cover all functions of the camera.

Assuming that the camera's IP address is **192.168.0.100**, you can access it by opening the Web browser and typing the following address into Web browser's address bar:

http://192.168.0.100

Upon successful connection to the camera, the user interface called **Web Configurator** would appear together with the login page. The HTTP port number was not added behind the IP address since the default HTTP port of the camera is 80, which can be omitted from the address for convenience.

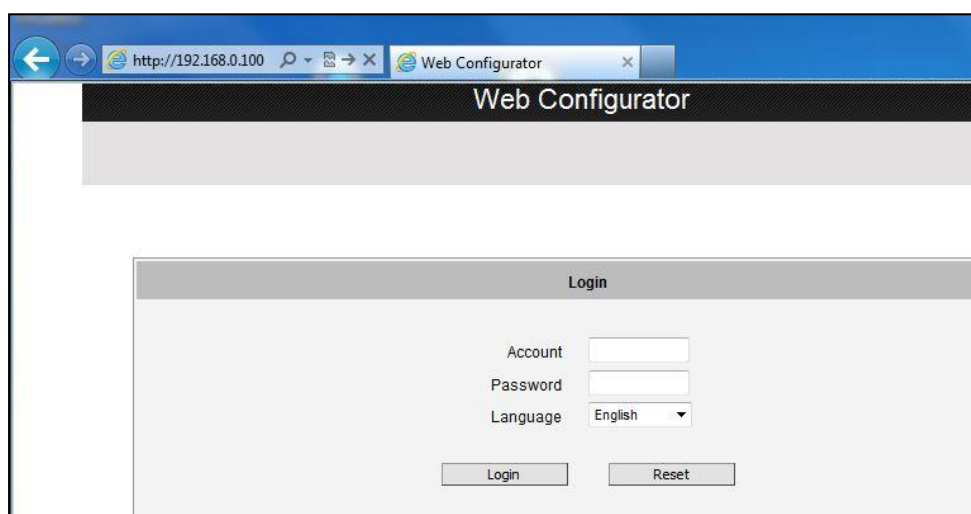

Before logging in, you need to know the factory default Account and Password of the camera.

Account: **Admin**

Password: **123456**

For further operations, please refer to the **Firmware User's Manual**.